

MATURO DYNAMOMETER

Technical Description

Dynamometer DYN 4WD - I

Integrated into

Turntable TT 7.5-5t-DYN

Customer	Project



1 Index

MATURO DYNAMOMETER.....	1
1 Index	2
2 DYNAMOMETER INTEGRABLE INTO TURNTABLE (TT – DYN).....	3
2.1 Technical Data of the Dynamometer DYN 4WD – 5t - I.....	3
2.2 EMC/EMI suitability.....	4
2.3 Brief description.....	5
3 Software and Controller	10
4 Highlights and advantages.....	14
5 Turntable TT 7.5 – 5t – DYN.....	15
5.1 Technical data of the Turntable	15
5.2 Brief description.....	16
6 Noise measurement results.....	19
6.1 According to CISPR 12 Standard	19
6.2 Magnetic field test results according to standard SAE J551-5-2004	20
6.3 Electric field test results according to standard SAE J551-5-2004.....	21
7 Utility requirements for the system.....	22

2 DYNAMOMETER INTEGRABLE INTO TURNTABLE (TT - DYN)

2.1 Technical Data of the Dynamometer DYN 4WD – 5t - I

TYPE	DYN – 30 kW
Axis 1 – Axis 2, automatic	1800 mm – 3700 mm
Total load / axis load	5.000 kg / 2.500 kg
Track width	1000 mm to 2300 mm
Roller diameter	240 mm
Roller properties	Flame coated surface (road-like) static heated up to 2000 rpm Balance quality: Q 2.5 according to VDI 2060
Maximum speed	120 km/h
Speed measurement accuracy	+/- 0.1 km/h
Acceleration / deceleration	max 1.0 g from 10 km/h to 60 km/h max 0.5 g from 60 km/h to 100 km/h
4 asynchrony servomotors/- generators	each 30 kW (total 60 kW per axis)
Rated torque	each 150 Nm
Max. torque	each 340 Nm
8 single axis inverters	Rectifier or rectifier/regeneration function
Voltage consumption	2x 380 V – 480 V / 3 phase
Current consumption	125 A
2 power supply devices	one per axis

The Dynamometer DYN-TT is constructed as a chassis dynamometer, which can be integrated into a turntable. The active axes are used for vehicles with rear/front or all-wheel drive with or without limited slip differential. The roller pairs are independently controllable, and each is driven by a separate motor/generator.

2.2 EMC/EMI suitability

The TT-DYN is especially designed not to influence EMC and EMI measurements. Therefore, the electronic components are inside a shielded, radio interference suppressing box which is placed inboard the dynamometer.

EMC Performances	
Emission	
Typically 10 dB under the limits of CISPR 12 and CISPR 25	
Frequency range	150 kHz – 1 GHz
Emission, electrical	
Typically 10 dB under the limits of SAE J551-5: 2004-1, GB/T 18387	
Frequency range	9 kHz – 30 MHz
Measurement distance	3 m
Emission, magnetic	
Typically 10 dB under the limits of SAE J551-5: 2004-1, GB/T 18387	
Frequency range	9 kHz – 30 MHz
Measurement distance	3 m
Immunity	
Continuous field strength	200 V/m
Frequency range	10 kHz – 18 GHz

All the design and manufacture of vehicle test bench is in accordance with standards below:

Ambient Noise requirements according to standards of CISR12, SAE J551-5

Vehicle velocity, acceleration, load, road simulation requirements and power grids requirements according to standards of CISR12, ISO11451, ECE R10, SAE J551, GB14023, GB18387, IEC61000-4-3, GB/T 14549.



2.3 Brief description

Control Unit

Each active element has two micro controllers to control the frequency inverters and for the speed measurement system. The element is connected to the system controller via fiber optic links. The system controller PC is equipped with an IEEE or LAN interface for remote control with a measurement software.

Safety and Emergency Functions

The maximum speed is limited by inverter function controller and by the internal micro controller. The temperature on the motors and inside the electronic box is being watched. Two emergency switches are located close to the stand and in the control room. In case of an emergency, the motor power will be switched off and the motors come to a standstill.

There are many features, benefits and accessories included in the standard delivery scope of maturo dynamometers. Furthermore, extra accessories are provided in order to ensure a safe, efficient and easier work for our customers.

Preserving the surroundings

Due to minimize the dynamic energy to the surrounding of the TT-DYN, the independent roller pairs are integrated into a "self-contained" frame.

Asynchronous – Servomotors from Bosch – Rexroth

- high reliability
- high dynamic
- possibility of energy recuperation
- whole dynamometer supplied by only one power cable

Twin rollers

- compact design of complete system
- quick test setup
- simple vehicle fixing



Tire cooling

- Extra cooling fans are installed below the rollers in order to avoid tires being damaged by heat



Tire safety cover

- Non-metal material
- Adjustable for different wheel tracks



Fixing points incl. lashing straps

- to fix the vehicle during tests
- lashing straps made of non-metal material
- shieldable fixing points integrated in the turntable cover plates



Exhaust system up to 400° C (optional)

- Movable soft exhaust pipe (up to 5 m) on turntable made of non-metallic material
- Integrated exhaust channels in turntable, each equipped with cover
- Fixed exhaust line underneath the cover, provided up to the honeycomb in the shielding wall



ABS and ESP tests

The dynamometer TT-DYN allows ABS and ESP testing of vehicles up to an acceleration or deceleration as described in the data specifications above.

Accessories included

- Four lashing straps to fix the vehicle while running. They are integrated in the system structure and are adjustable to each specific vehicle and made of neutral material.
Tensile strength: 5000 N
Length adjustment: 1.0 m – 6.0 m
- Roller blocking system for easy loading or unloading of the vehicle
- Two emergency switches, one close to the dynamometer and one inside the control room.
- Triggering the switch sets all rollers to torque-free mode to prevent vehicle damage
- Safety cover for tires

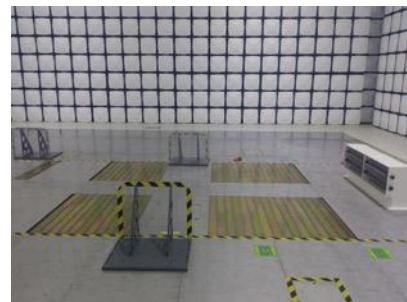
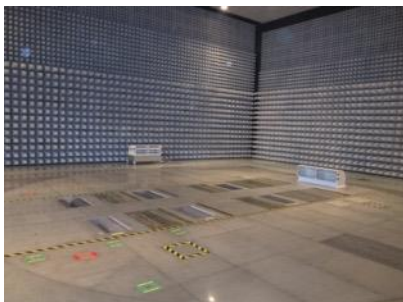

Robot R – AB for accelerator and brake pedal (optional)

- Remote controlled vehicle driving on chassis dynamometer for EMC tests
- Actuation of pedal positions to external, analogue setpoints
- Safe non-energized basic positions
- Quick snap-in mechanism of pedal actuator for individual settings
- Easy mounting in vehicle
- No EMC emission due to pneumatic operation

Technical data	
Stroke distance accelerator stepless adjustable	up to 100 mm
Strength	200 N
Stroke distance brake stepless adjustable	up to 125 mm
Strength	350 N
Power consumption	208 VAC – 230 VAC, 50Hz / 60 Hz, single phase
Current consumption	approx. 0.5 A
Fuse	2 A, 250 V
Compressed air supply	via pressure regulator and 0.5 inch quick connector
Signal pressure	0.2 – 1.0 bar
Nominal pressure	5 bar
Length of lines	Air tube 5 m from dynamometer to robot
Operating temperature	5° C – 40° C
Total weight	approx. 25 kg



Power supply for DUT/EUT (optional)

- DUT/EUT power supply distribution via energy chain to the connection boxes (access panels) outside the turntable center
- Integration of various socket and connector types for the DUT/EUT power supply, incl. charging points for electric vehicles
 - 1x 1000 V / 250 A / DC
 - 1x 380 V / 100 A / AC



Energy chain principle:

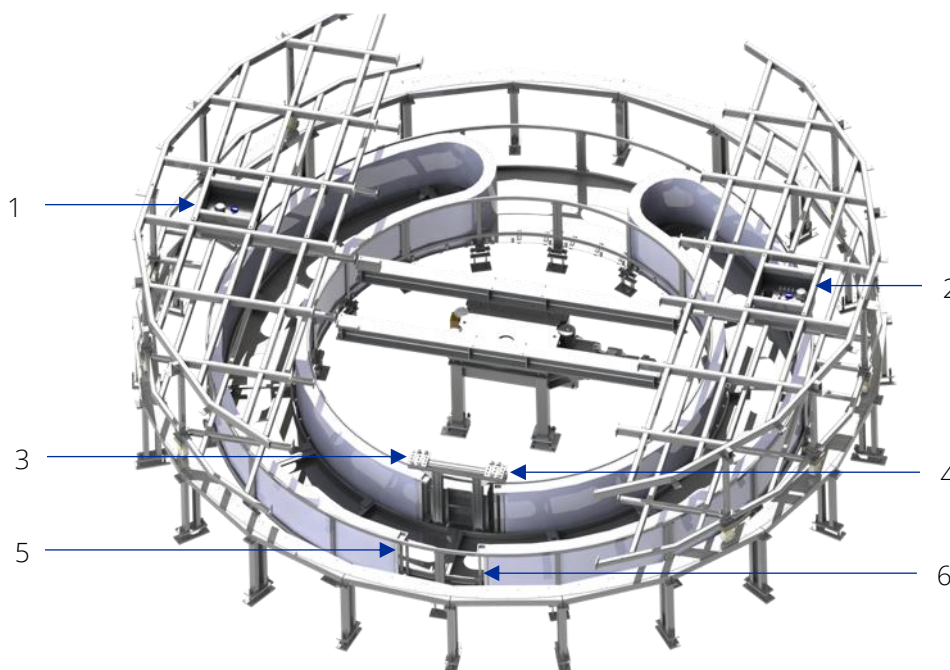

- 1 and 2 decentral access panels
- 3 and 4 rotating ends of the energy chains (mounted on the turntable)
- 5 and 6 fixed ends of the energy chains (mounted on the floor)

Power supply lines come from outside the chamber to the fixed positions (5 and 6). From there they are guided through the energy chain to the rotating ends (3 and 4). Due to the fact that the decentral access panels and the rotating energy chain ends are fixed to the rotating turntable, the distances are always constant between 1 and 3 and between 2 and 4. Therefore the power lines are connected from 3 to 1 and from 4 to 2 without any issues during rotation.

3 Software and Controller

The maturo controller DynSoft is developed by maturo engineers based on long experience. The in-house software is able to control all maturo dynamometers and their accessories, e.g. the cooling fans, the robot and so on. It will be delivered with an industrial PC and communicate with the devices by fiber optics.

Due to the fact that the controller and the software are exclusively produced, developed and constantly enhanced by maturo, software maintenance or troubleshooting in case of failing components can be done very fast, optionally with a remote service unit, for minimal downtimes.

The included software contains the following functions:

- Emergency stop
- Start cycle / stop cycle
- Speed control of the rollers
- Speed control of the ventilator
- Force at the rim (in Nm)
- Distance gone from the start of the cycle (in km)
- Cycle recording (profile)

To allow the following test cycles:

- Constant velocity
- Velocity gradient
- Simulation of uphill and downhill driving
- Tractive force control
- Friction force control
- Positive and negative rotation control
- ABS, ESP testing
- Road load simulation based on the GB/T 18387 standard

The software includes:

- PC-Controller with keyboard, mouse and monitor
- The DYN-Software is pre-installed at the PC



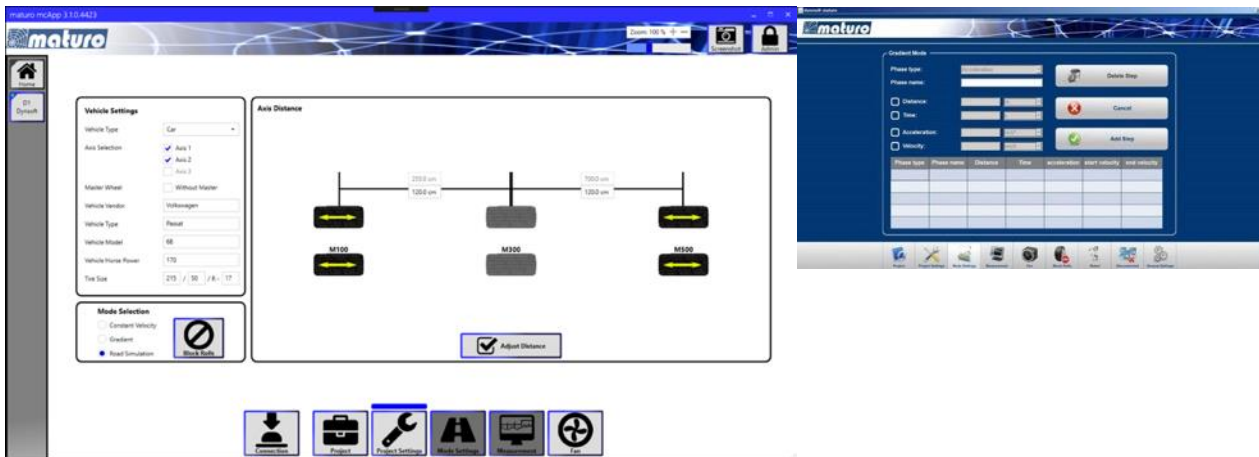

Operating modes:

In all operation modes, the difference between road and roller friction can be easily corrected by the electric motors. The different friction leads to a different torque against the vehicle. The DynSoft transfer this difference to the electric motors in such a way that the friction load for the vehicle on the dynamometer is almost the same as on the road.

- Recuperation mode: The dynamometer drives with constant speed and can load vehicle batteries. It is possible to set a certain acceleration, deceleration or speed.
- Gradient mode: Individual profiles, which can be set for each wheel independently

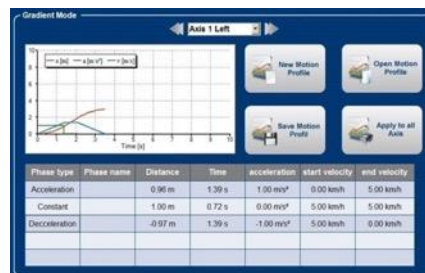
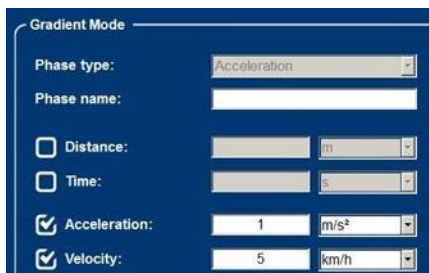

- Road simulation: The resistive torque is adjusted by the so-called coefficient setting method (A, B, C) based on the GB/T 18387. This means that the weight of the vehicle is set, and the software generates the coefficients automatically. Additionally, the coefficients can be set manually and independently of the weight.

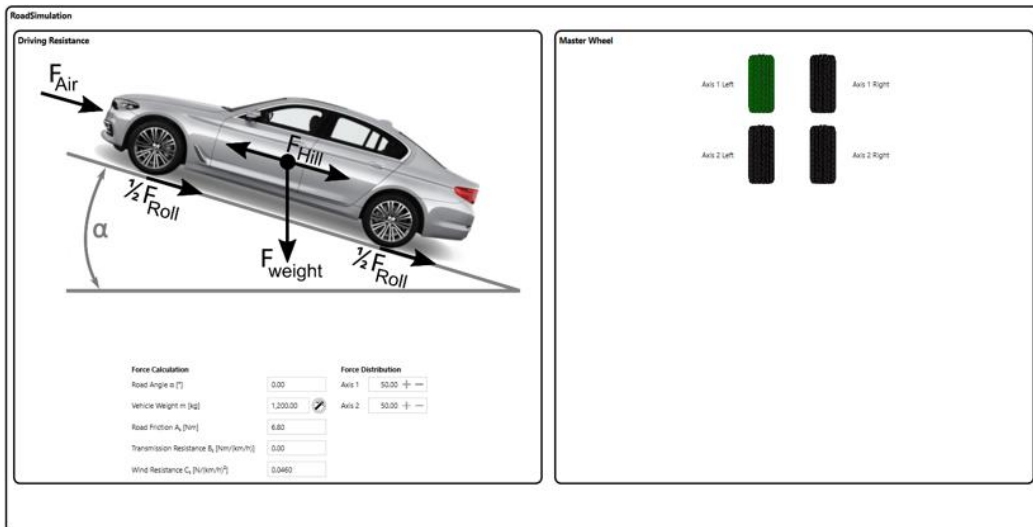

Additional to the coefficient setting method, a road angle and the force distribution at more wheel drives could be also set.

As example see the following picture. Herein, the vehicle weight is set to 1200 kg and the three coefficients are generated automatically.

Force Calculation		Force Distribution	
Road Angle α [°]	<input type="text" value="0.00"/>	Axis 1	<input type="text" value="50.00"/> + -
Vehicle Weight m [kg]	<input type="text" value="1,200.00"/> 	Axis 2	<input type="text" value="50.00"/> + -
Road Friction A_r [Nm]	<input type="text" value="6.80"/>		
Transmission Resistance B_t [Nm/(km/h)]	<input type="text" value="0.00"/>		
Wind Resistance C_w [N/(km/h) ²]	<input type="text" value="0.0460"/>		

The coefficients are stored in an external list, which could be edit by customer. Different values more or less are possible. For example, see the extract of that list:

	A	B	C	D	E	F
1	ns1:A	ns1:B	ns1:C	ns1:MassRangeLower	ns1:MassRangeUpper	
2	3,8	0	0,0261	-3,40282E+38	480	
3	4,2	0	0,0282	480	540	
4	4,4	0	0,0296	540	595	
5	4,6	0	0,0309	595	650	

- Measurement: For each single wheel the following parameters can be measured and visualized in a graph:
 - Current torque of the motor in Nm
 - Current speed of the wheel in km/h
 - Current power of the motor in W
 - Current rotations of the vehicle wheel in rpm

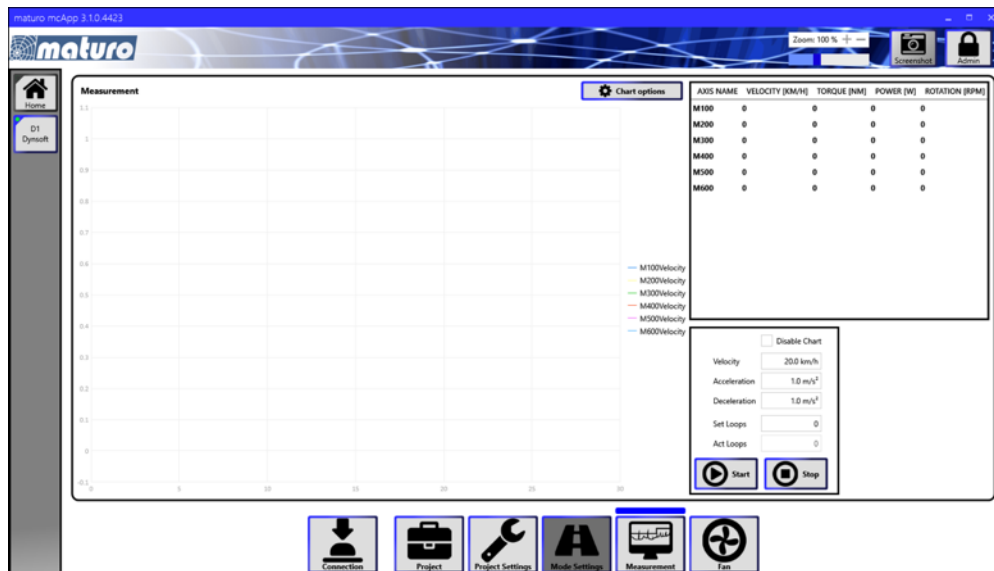

- Roll blocking mode for easy setup of the vehicle
- ESP/ABS mode (optional): Different torque on rollers for testing the ESP and ABS function

Control inside the chamber with HCU

The handheld control unit HCU is connected inside the chamber at the turntable for fine adjustments of:

- The maturo robot
- Axle distance adjustment of the dynamometer
- Rotation of the turntable



4 Highlights and advantages

- The software DynSoft is developed completely by maturo engineers
- Due to the in-house software very short response time in case of service
- Axis distances automatically adjustable over DynSoft
- Full functionality of the Handheld control unit
 - Stay in the chamber and control all functions of the dynamometer, such as the axle distance, roller speed and so on
- Twin roller system for short setup-time, tire-sparing design and due to lower moment of inertia quick reaction to velocity changes
- Maintenance-free energy chain
- Exclusively well-known suppliers with subsidiaries all over the world
 - Short delivery times for spare parts

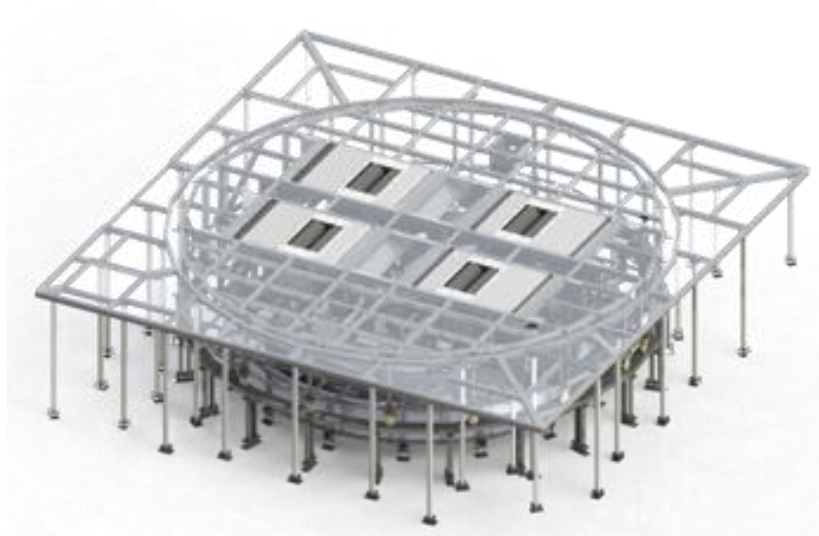

5 Turntable TT 7.5 - 5t - DYN

5.1 Technical data of the Turntable

Type	TT 7.5 – 5t
Diameter	7.5 m
Load capability	5.000 kg
Height	2000 mm
Material cover plate	stainless steel
Rotating speed adjustable	0.1 rpm – 0.5 rpm
Rotating angle	from – 200° to + 200°
Position accuracy	better +/- 0.5°
Motor	servo motor, frequency inverter
Interference suppression	20 dB under limits EN 55022 class B
Turntable drive	bevel gear
Control cable	Fiber optic lines
Current consumption	max. 32 A
Voltage	380 VAC – 400 VAC, 50 Hz / 60 Hz three phases
Concentricity tolerance	+/- 3mm
Elevation tolerance	< 5 mm
Ground plane connecting	every 50 mm
Square border interface	8.5 m x 8.5 m, stainless steel
Operating temperature	5° C – 40° C
Accessories	Interface to Controller Service manual

5.2 Brief description

The turntable TT -DYN is especially designed for flush mounted installation at intermediate levels in electromagnetic absorption chambers. The framework design allows the possibility to integrate a chassis dynamometer.

Movement

The rotation of the turntable can also be carried out while the chassis dynamometer is in operation. The angle is measured by a position encoder.

Safety for EUT

For the safety of the EUT, the turntable is equipped with an acceleration/deceleration function for start and stop ramps to avoid jerky movements

Emergency switch

The turntable is equipped with an integrated emergency switch, which can be connected at the turntable perimeter.

Limit switches

The turntable is equipped with a limit switch and positioning switch system to guarantee the exact positioning of the turntable. An "overturning" of the system is prevented by using limit switches.

Power supply in the center of the turntable

It is possible to integrate various types of connectors for the power supply of the EUT

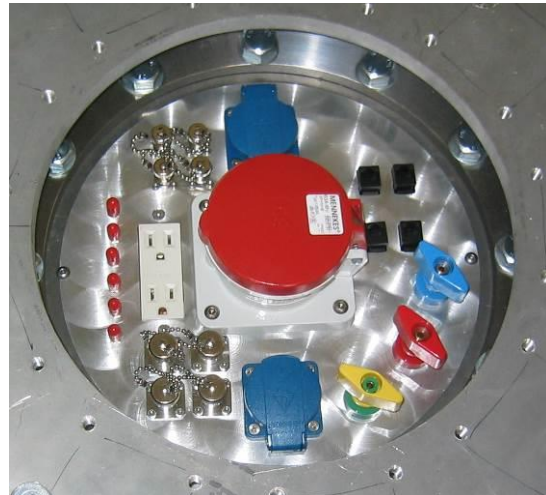

Connection to the ground plane

Systems included a long-lasting, maintenance-free contact:
Material: hollow core copper beryllium tubing



Heavy-duty roller bearing

A heavy-duty roller bearing in the center of the turntable supports high axial and radial loads.



Heavy-duty castors:

Roller bearing heavy-duty castors at the turntable structure additionally support the high axial forces at the outer diameter of the turntable.

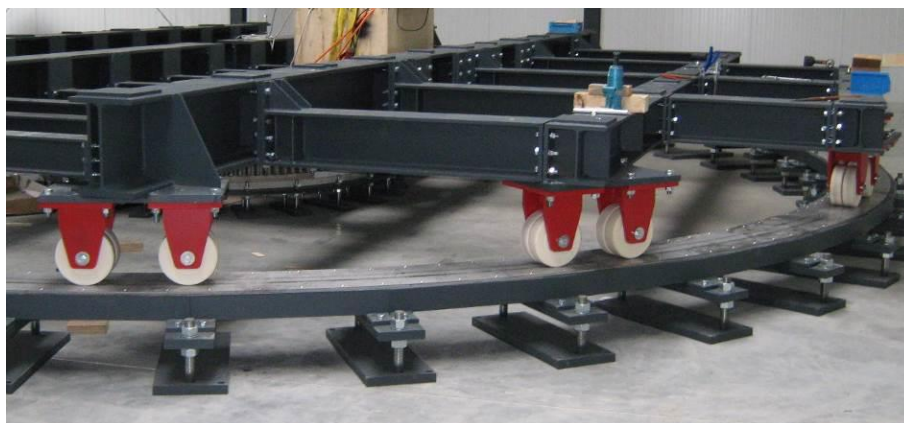

Roller track

The heavy-duty castors run along a height adjustable runway structure at the edge of the turntable. The structure is made of a welded steel structure and a stainless-steel runway for a low noise operation.



Turntable structure

Solid welded steel construction; parts are assembled with screws (for easy transportation). The complete structure is either pre-coated and painted or galvanised for long-lasting performance of the system.



Service hatch

There is a service hatch at the rim of the turntable, which allows easy access above the turntable for maintenance works. The opening is covered with a removable stainless-steel cover and is equipped with a ladder.

Size: approx. 0.8 m x 0.8 m



6 Noise measurement results

6.1 According to CISPR 12 Standard

The graph below shows the EMC test results from 30 MHz to 1 GHz of a turntable with integrated active dynamometer at Nissan, USA



Title: Narrowband
File: Dyno noise suppression test_6.set
Operator: Stephan
EUT Type: Dyno noise suppression
EUT Condition:
Comments: Shielded wire
Dyno at -90 degrees

8/19/2013 3:22:16 PM
Sequence: Preliminary Scan

Graph27

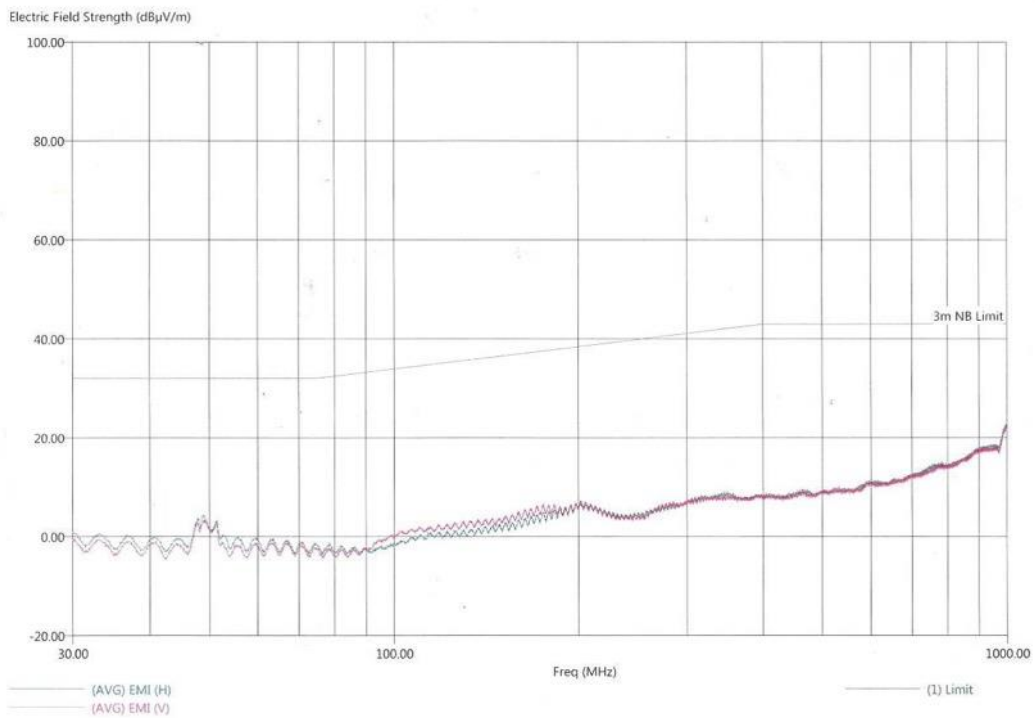





6.2 Magnetic field test results according to standard SAE J551-5-2004

The graph below shows the magnetic field test results from 9 KHz to 30 MHz of a turntable with integrated active dynamometer at BYD, China

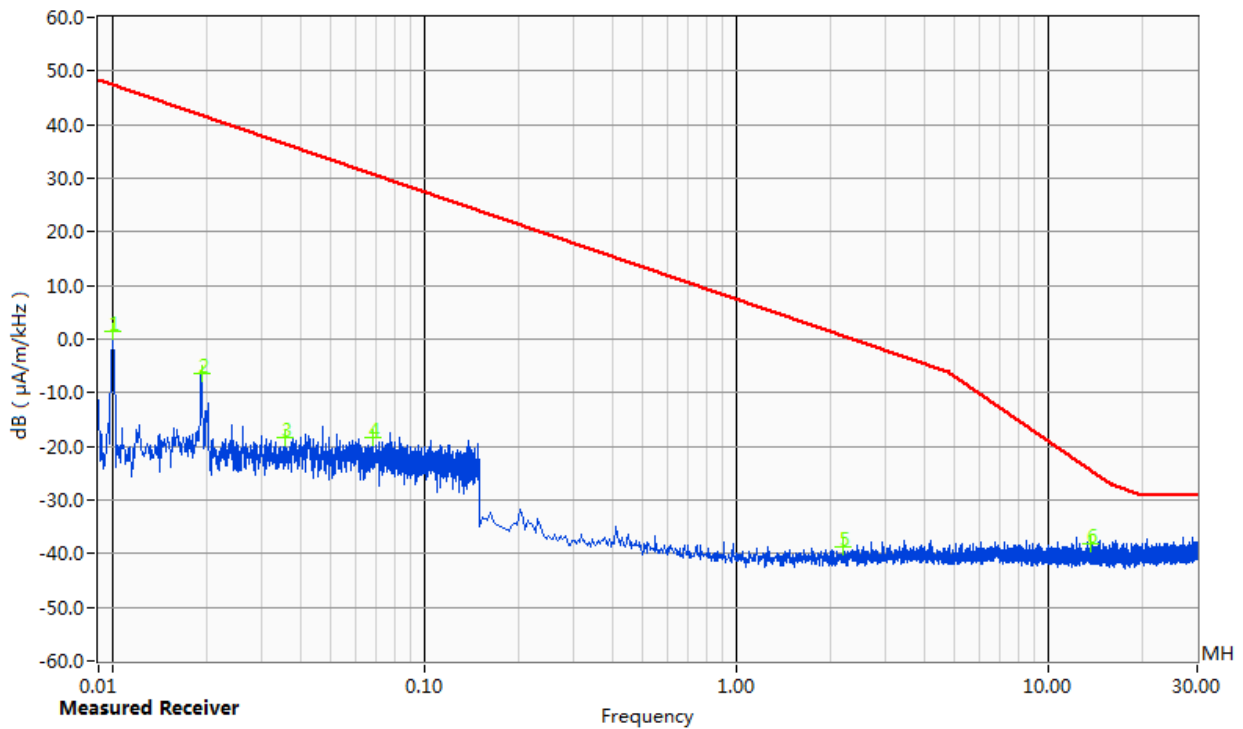

Standard	SAE J551-5-2004
Test Distance	3 m
Antenna Height	1 m
Antenna Polarization	Z
Dynamometer Status	50 km/h (all three axes running)







	SAE J551-5-2004
	PK - Curve
	PK - Point

6.3 Electric field test results according to standard SAE J551-5-2004

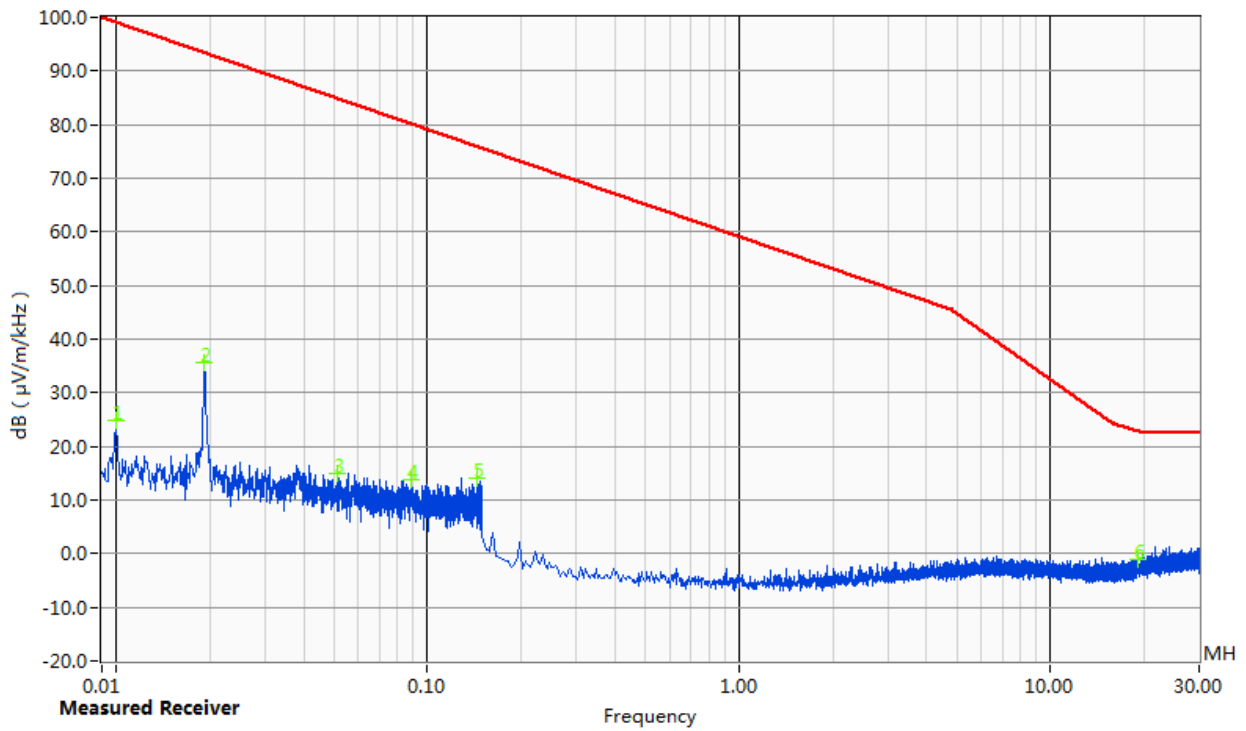
The graph below shows the electric field test results from 9 KHz to 30 MHz of a turntable with integrated active dynamometer at BYD, China

Standard	SAE J551-5-2004
Test Distance	3 m
Antenna Height	1 m
Antenna Polarization	Vertical
Dynamometer Status	50 km/h (all three axes running)



	SAE J551-5-2004
	PK - Curve
	PK - Point

7 Utility requirements for the system

Filters

The following filters have to be provided by the chamber manufacturer for the operation of the system.

For the dynamometer	
Voltage	2x 380-400 V/ 3-phase
Current consumption	125 A (total 250 A are required)
For the turntable	
Voltage	1x 380-400 V/ 3-phase
Current consumption	32 A
Voltage	1x 380-400 V/ 3-phase

Pit

Pit requirements	
Dimensions in mm (L x W)	8400 x 8400
Depth in mm	2000
Load capacity	2.500 kg/m ² including the concrete basement shielding

Exhaust extraction

Connection tube with honeycomb in the shielded wall for connection of the exhaust hose
Dimension needs to be discussed

Compressed air

For the roller brake system compressed air is required. Optionally, it is also necessary for the robot and when the system is used in combination with a pneumatic Antenna Mast.

Compressed air requirements	
Air pressure	6 bar
Capacity	Approx. 0.4 m ³ /h