

Turntable TT 5.0 - 5t

Technical data:

Diameter	5.0 m
Load capability	5000 kg
Point load	750 kg at 10 cm x 10 cm
Height	600 mm
Material cover plate	Stainless steel
Rotating speed adjustable	0.1 rpm – 1.5 rpm
Positioning accuracy	+/- 0.5°
Rotating angle	-200° to 400°
Motor	Synchronous servo motor
Turntable drive	Worm gear
Elevation tolerance	< 3 mm
Gap between TT and the surrounding	< 5 mm
Concentricity tolerance	+/- 1 mm
Ground plane connecting	every 50 mm
Square border interface (easy fitting into ground plane of chamber)	5.5 m x 5.5 m
Voltage	380 VAC – 480 VAC, 50 Hz / 60 Hz, three phases
Current consumption	max. 16 A
Required RCD	300 mA
Control cable	Fiber optic lines
Remote control via	LAN (TCP/IP); (IEEE only with NCD)
Interference suppression	20 dB under limits DIN EN 55011:2018-05 class B
Temperature working range	10° C – 35 ° C
Total weight	approx. 5500 kg
Accessories	Service manual Standard CP equipped with: <ul style="list-style-type: none">- 2x Schuko 230V/16A- 1x CEE 400V/16A 3 phase

Brief description

The turntable TT 5.0-5t is especially designed for flush mounted installation in semi anechoic electromagnetic absorption chambers. The carrier plate is made of stainless steel.

The LAN (TCP/IP) - interface provides an additional control option for all functions, when operated with the FCU^{3.0} or NCD Controller.

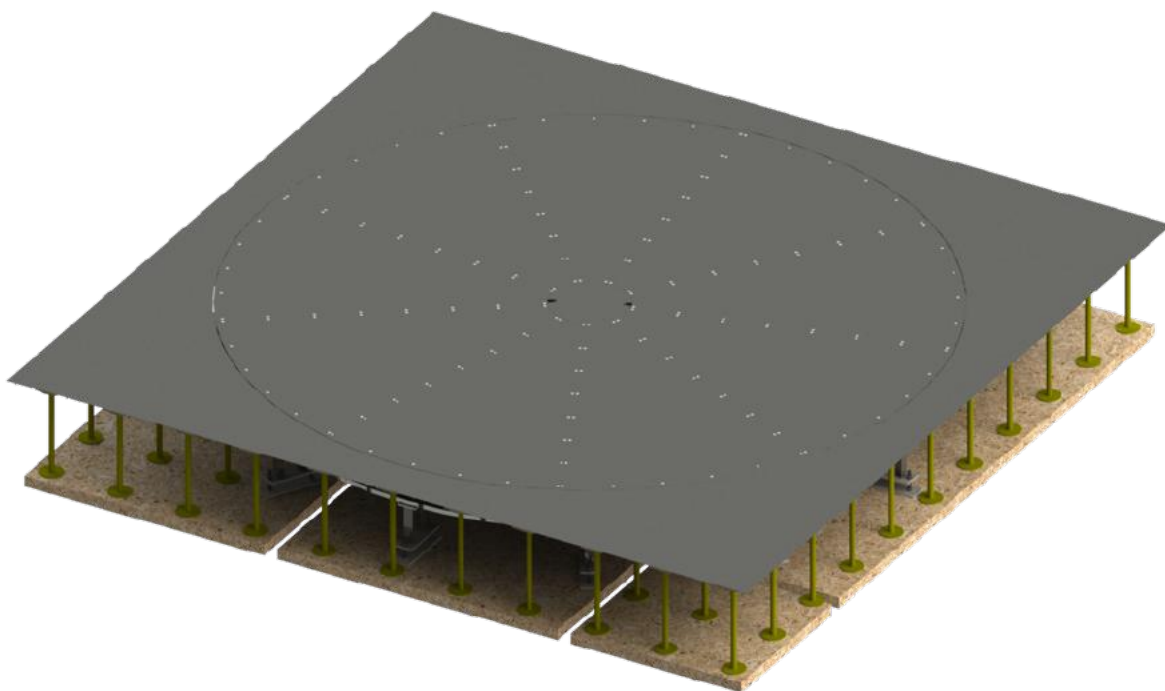

Power supply in the turntable center

It is possible to integrate various types of connectors for the power supply of the EUT. A standard 450 mm diameter opening in the center of the turntable provides the capability to insert power supply for testing, other diameters on request.



Standard center plate

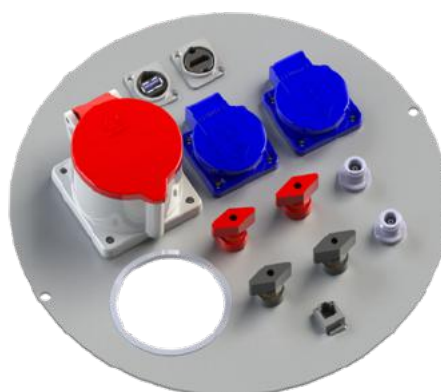

Example for a customized center plate

Rotary encoder and limit switch

The turntable is equipped with a rotary encoder to guarantee the exact positioning of the turntable.

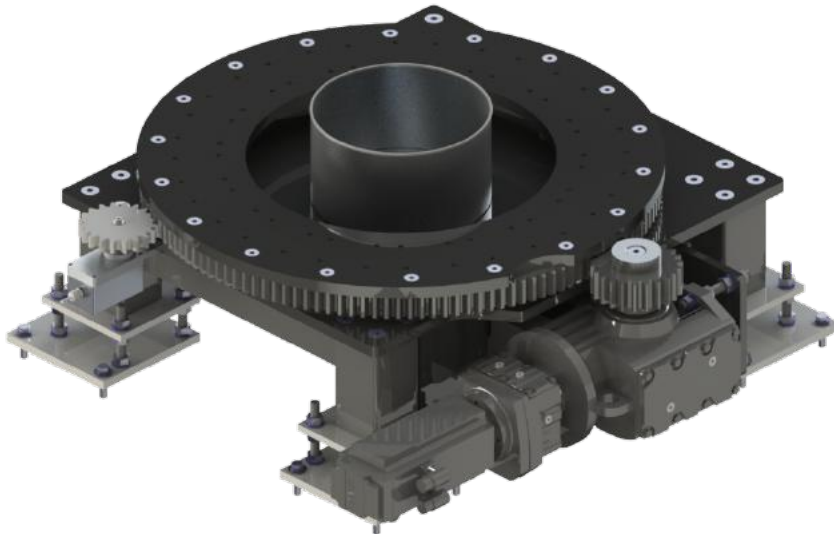

Rotary encoder and limit switch system

Connection to ground plane

A long-lasting, maintenance-free contact system is included, which is made by hollow core copper beryllium tubing.

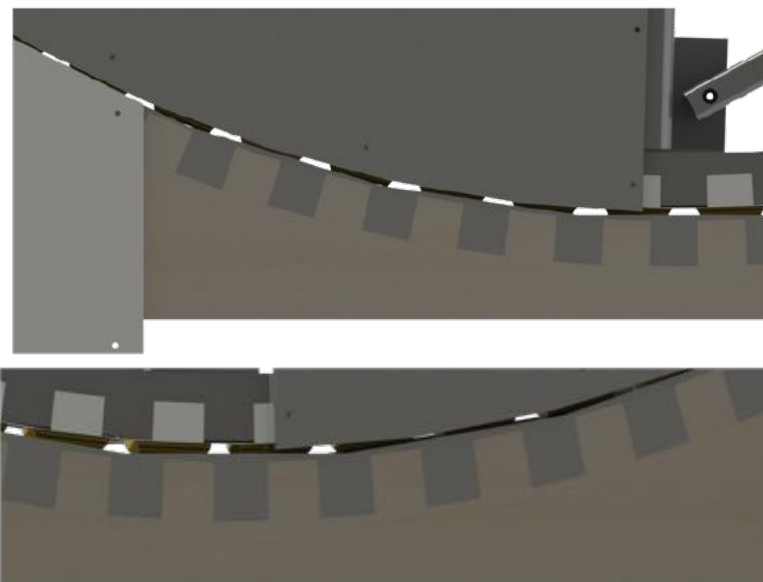

Contact system between the turntable and the surrounding

Turntable structure:

Solid welded steel construction; parts are assembled with screws (for easy transportation). The complete structure is either pre-coated and painted or galvanised for long-lasting performance of the system.



Turntable structure made of solid welded steel

Further specifications and options available upon request

The following options are available upon request:

- Power supply in the centre with different connectors
- External power supply outside the centre with energy chain
- Continuous rotation with integrated slip rings or rotary joints
- Integrated exhaust gas extraction system
- Integrated cooling fan system
- Vehicle charging possibility
- Maintenance hatch
- Higher positioning accuracy
- Outdoor applications

Information presented enclosed is subject to change as product enhancements are made regularly. Pictures included are for illustration purposes only and do not represent all possible configurations.